

QUALITY PRODUCTS OF
ISO 9002 CERTIFIED

DT-9M

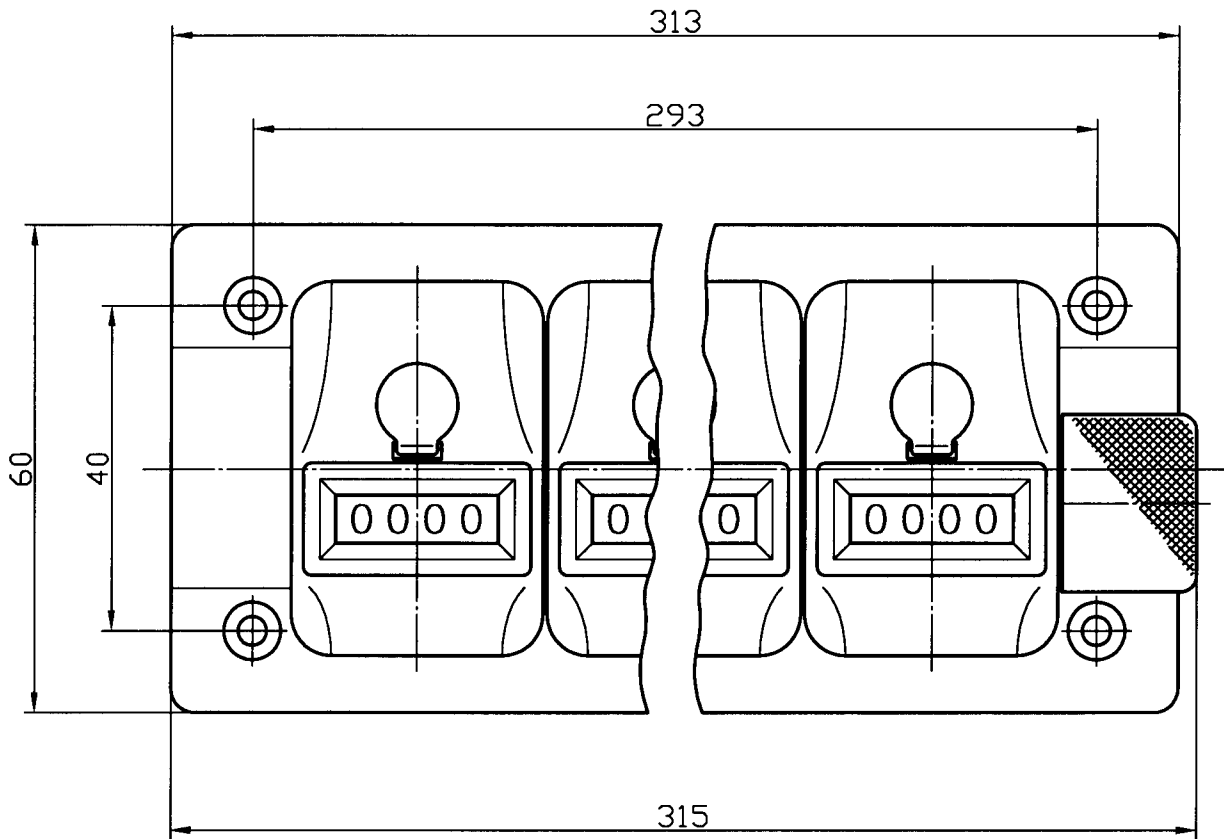

 GLOBAL INDUSTRIAL PRODUCTS
SPECIALISTS IN ADVANCED
OEM COMPONENT
TECHNOLOGIES

3338 WEST LAKE ST.
GLENVIEW, IL 60025 U.S.A.
TOLL FREE 800.951.8774
TEL 847.901.4040
FAX 847.901.4036
E-Mail sales@globalepower.com
www.globalepower.com

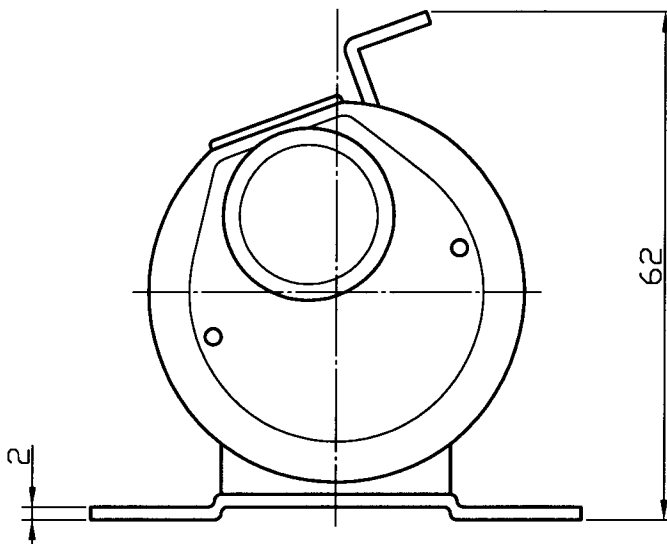

SCALE=2:1